

# PRODUCT SPECIFICATIONS

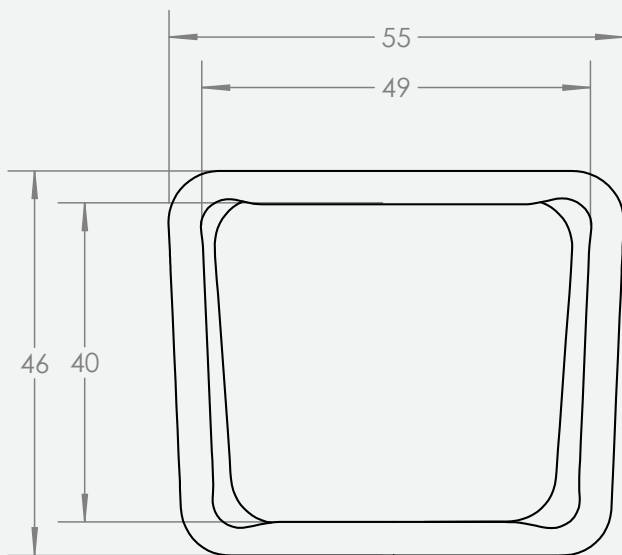

top view

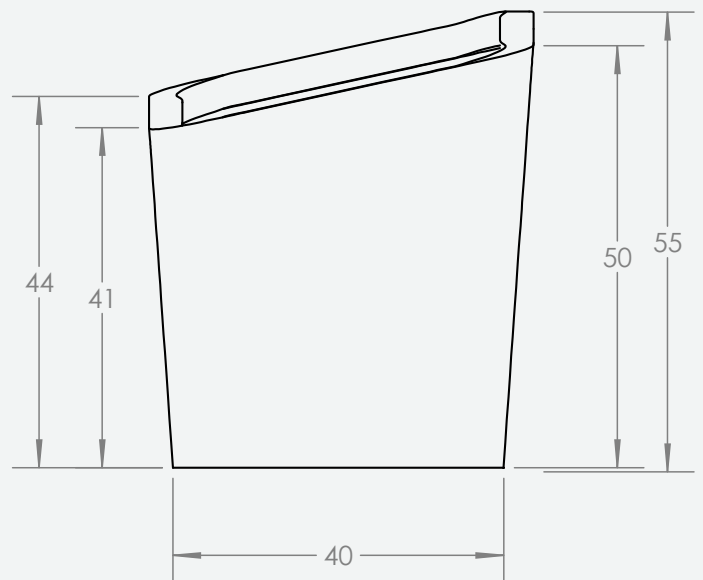

detailed view

## Product Specifications

Outside Dimensions (cm)			Inside Dimensions (cm)		Weight (kg)
L x W	H	Base	L x W		Net
55/46	55	43/40	49/40		4.90

## ORGANICUM

Model. NO.

**7850.046**

**A4**

SHEET 1 OF 1